



www.FGWilson.com

P2000-1/P2000-1E



Image for illustration purposes only.

Output Ratings

Voltage, Frequency	Prime	Standby
400V, 50Hz	1850.0 kVA / 1480.0 kW	2000.0 kVA / 1600.0 kW
	- / -	- / -

Ratings at 0.8 power factor.

Please refer to the output ratings technical data section for specific generator set outputs per voltage.

Prime Rating

These ratings are applicable for supplying continuous electrical power (at variable load) in lieu of commercially purchased power. There is no limitation to the annual hours of operation and this model can supply 10% overload power for 1 hour in 12 hours.

Standby Rating

These ratings are applicable for supplying continuous electrical power (at variable load) in the event of a utility power failure. No overload is permitted on these ratings. The alternator on this model is peak continuous rated (as defined in ISO 8528-3).

Standard Reference Conditions

Note: Standard reference conditions 25°C (77°F) Air Inlet Temp, 100m (328 ft) A.S.L. 30% relative humidity.
Fuel consumption data at full load with diesel fuel with specific gravity of 0.85 and conforming to BS2869: 1998, Class A2.

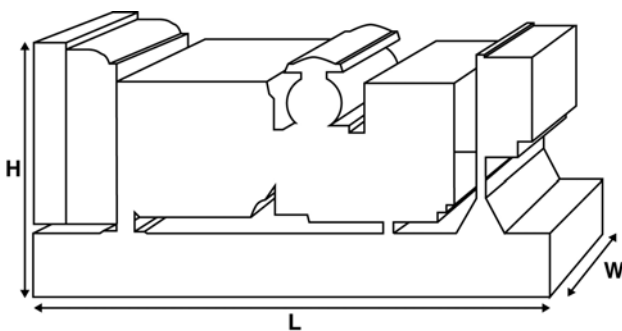

Ratings and Performance Data

Engine Make & Model:	Perkins® 4016-61TRG1	
Alternator manufactured for FG Wilson by:	Leroy Somer	
Alternator Model:	LL9224F	
Control Panel:	PowerWizard 1.1+	
Base Frame:	Heavy Duty Fabricated Steel	
Circuit Breaker Type:	3 Pole ACB – Option	
Frequency:	50 Hz	60 Hz
Engine Speed: RPM	1500	-
Fuel Tank Capacity: litres (US gal)	-	
Fuel Consumption: l/hr (US gal/hr)		
(100% Load)	- Prime	385.4 (101.8) -
	- Standby	410.8 (108.5) -

Available Options

FG Wilson offer a range of optional features to tailor our generator sets to meet your power needs. Options include:

- Upgrade to CE Certification
- A wide range of Sound Attenuated Enclosures
- A variety of generator set control and synchronising panels
- Additional alarms and shutdowns
- A selection of exhaust silencer noise levels

For further information on all of the standard and optional features accompanying this product please contact your local Dealer or visit: www.FGWilson.com

Dimensions and Weights

Length (L) mm (in)	Width (W) mm (in)	Height (H) mm (in)	Dry kg (lb)	Wet kg (lb)
5672 (223.3)	2176 (85.7)	2605 (102.6)	12187 (26868)	12502 (27562)
Dry = With Lube Oil		Wet = With Lube Oil and Coolant		

Ratings in accordance with ISO 8528, ISO 3046, IEC 60034, BS5000 and NEMA MG-1.22. Generator set pictured may include optional accessories.

Engine Technical Data		
No. of Cylinders / Alignment:	16 / 60Deg Vee	
Cycle:	4 Stroke	
Bore / Stroke: mm (in)	160.0 (6.3)/190.0 (7.5)	
Induction:	Turbocharged Air To Water Charge Cooled	
Cooling Method:	Water	
Governing Type:	Electronic	
Governing Class:	ISO 8528 G2	
Compression Ratio:	13.0:1	
Displacement: l (cu. in)	61.1 (3730.0)	
Moment of Inertia: kg m ² (lb/in ²)	20.72 (70803)	
Engine Electrical System:		
- Voltage / Ground	24/Negative	
- Battery Charger Amps	55	
Weight: kg (lb)	- Dry	5570 (12280)
	- Wet	5847 (12890)

Performance	50 Hz	60 Hz
Engine Speed: rpm	1500	-
Gross Engine Power: kW (hp)		
- Prime	1648.0 (2210.0)	-
- Standby	1774.0 (2379.0)	-
BMEP: kPa (psi)		
- Prime	2157.0 (312.8)	-
- Standby	2322.0 (336.8)	-

Fuel System					
Fuel Filter Type:	Replaceable Element				
Recommended Fuel:	Class A2 Diesel or BSEN590				
Fuel Consumption: l/hr (US gal/hr)					
	110%	100%	75%	50%	
Prime	Load	Load	Load	Load	
50 Hz	410.8 (108.5)	385.4 (101.8)	300.9 (79.5)	207.6 (54.8)	
60 Hz	-	-	-	-	
		100%	75%	50%	
Standby		Load	Load	Load	
50 Hz		410.8 (108.5)	322.3 (85.1)	223.3 (59.0)	
60 Hz		-	-	-	

(Based on diesel fuel with a specific gravity of 0.85 and conforming to BS2869, Class A2)

Air Systems	50 Hz	60 Hz
Air Filter Type:	Replaceable Element	
Combustion Air Flow: m ³ /min (cfm)		
- Prime	155.0 (5474)	-
- Standby	165.0 (5827)	-
Max. Combustion Air Intake Restriction: kPa (in H ₂ O)	3.7 (14.9)	-

Cooling System	50 Hz	60 Hz
Cooling System Capacity: l (US gal)	315.0 (83.2)	-
Water Pump Type: Centrifugal		
Heat Rejected to Water & Lube Oil:		
kW (Btu/min)	- Prime 620.0 (35259)	-
	- Standby 666.0 (37875)	-
Heat Radiation to Room: Heat radiated from engine and alternator		
kW (Btu/min)	- Prime 186.6 (10612)	-
	- Standby 209.0 (11886)	-
Radiator Fan Load: kW (hp)	78.0 (104.6)	-
Radiator Cooling Airflow: m ³ /min (cfm)	2081.4 (73504)	-
External Restriction to Cooling Airflow: Pa (in H ₂ O)	250 (1.0)	-

Designed to operate in ambient conditions up to 50°C (122°F).
Contact your local FG Wilson Dealer for power ratings at specific site conditions.

Lubrication System	
Oil Filter Type:	Spin-On, Full Flow
Total Oil Capacity: l (US gal)	238.0 (62.9)
Oil Pan: l (US gal)	213.0 (56.3)
Oil Type:	API CG 15W-40 CH4
Oil Cooling Method:	Water

Exhaust System	50 Hz	60 Hz
Maximum Allowable Back Pressure: kPa (in Hg)	4.0 (1.2)	-
Exhaust Gas Flow: m ³ /min (cfm)		
- Prime	400.0 (14126)	-
- Standby	400.0 (14126)	-
Exhaust Gas Temperature: °C (°F)		
- Prime	400 (752)	-
- Standby	425 (797)	-

Documentation

A full set of operation and maintenance manuals and circuit wiring diagrams.

Generator Set Standards

The equipment meets the following standards: BS5000, ISO 8528, ISO 3046, IEC 60034, NEMA MG-1.22.

FG Wilson is a fully accredited ISO 9001 company.

Warranty

All prime equipment carries a one year manufacturer's warranty with unlimited hours or two year manufacturer's warranty limited to 6,000 running hours. Standby equipment, limited to 500 running hours per year, has a three year manufacturer's warranty.

Dealer contact details:



FG Wilson manufactures product in the following locations:

Northern Ireland • Brazil • China • India • USA

With headquarters in Northern Ireland, FG Wilson operates through a Global Dealer Network.

To contact your local Sales Office please visit the FG Wilson website at www.FGWilson.com.

FG Wilson is a trading name of Caterpillar (NI) Limited.

In line with our policy of continuous product development, we reserve the right to change specification without notice.